



ASSEMBLY ARRANGEMENTS

PTO SERIES TYPE SAE RECOMMENDED PRACTICE J772 ENVELOPE TYPE

SG

I

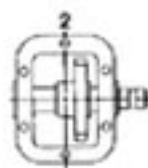
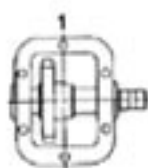
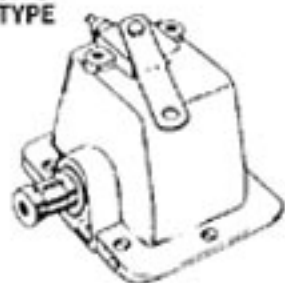

TG

II

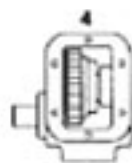
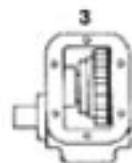
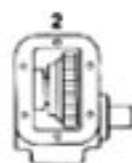
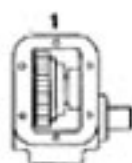
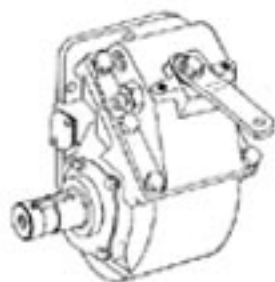

CD

N.A.

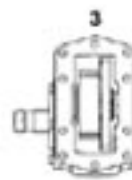
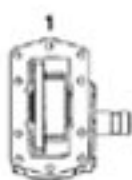
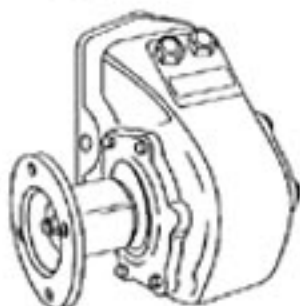

CS6

IV

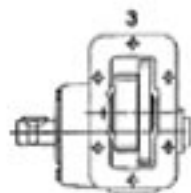
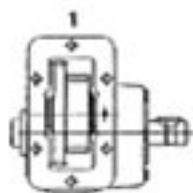
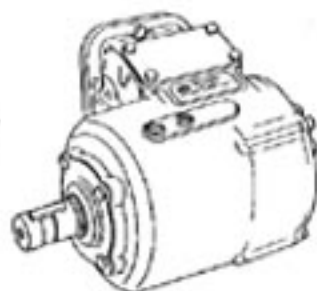

CS10

N.A.

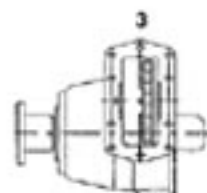
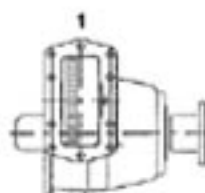
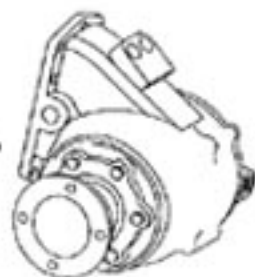

CS20

IV

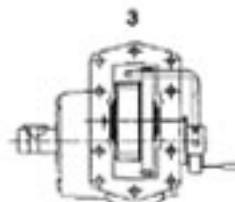
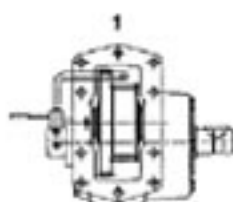



ASSEMBLY ARRANGEMENTS

PTO SERIES TYPE SAE RECOMMENDED PRACTICE J772 ENVELOPE TYPE

RG

III

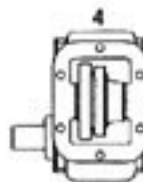
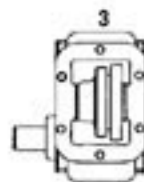
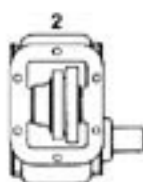
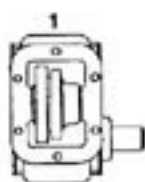
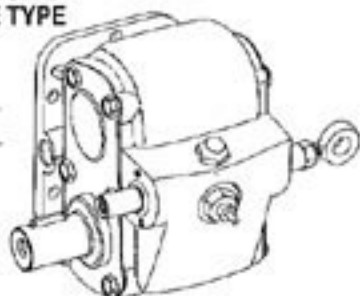

RL

III

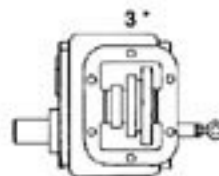
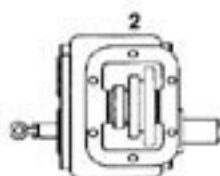
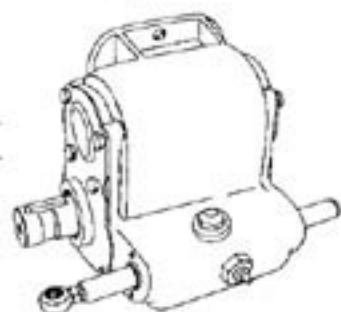

* The 03 speed ratio has a reduction gear box (not shown) attached to the output shaft of the RL PTO and is only available in the "3" arrangement.

RX

III

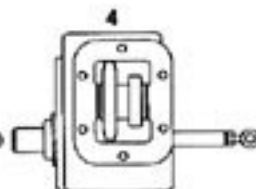
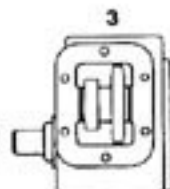
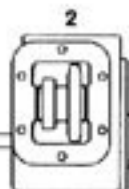
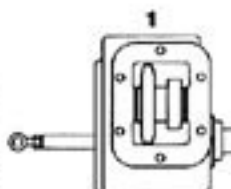
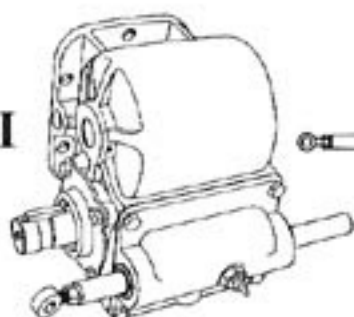

SD

IV

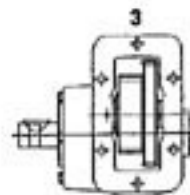
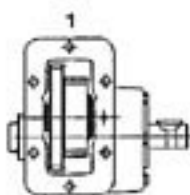
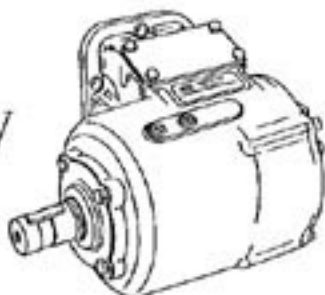

82

VI

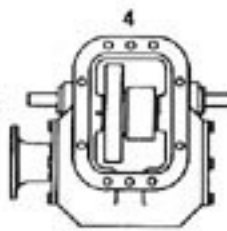
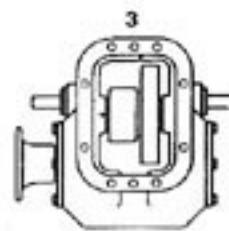
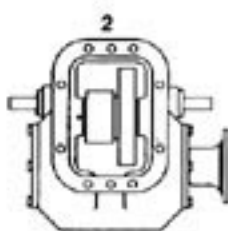
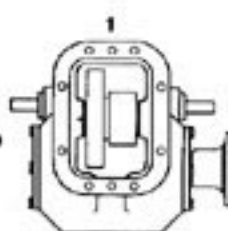
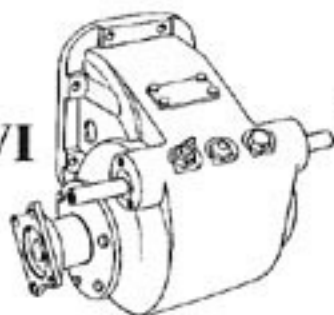

83

VI

